

NPR75FH-VI-C / NPR75FHE-VI-C

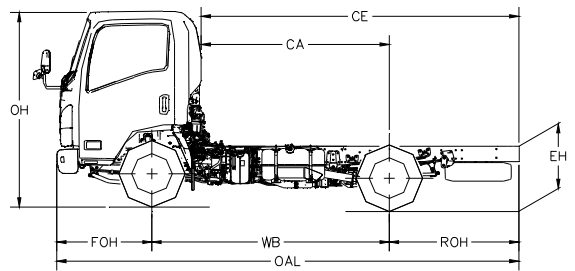

型號 (Model)	OAL	WB	FOH	ROH	CE	CA	OW	BW	CW	OH Approx	EH Approx	
NPR75FH-VI-C / NPR75FHE-VI-C	5385	2765	1110	1510	3702	2192	1995	2135	1650	2245	835	毫米 (mm)
	212.0	108.9	43.7	59.4	145.7	86.3	78.5	84.1	65.0	88.4	32.9	寸 (in)

NPR75HH-VI-C / NPR75HHE-VI-C

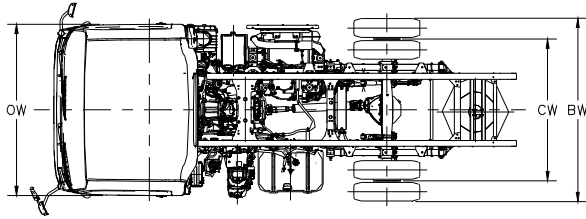
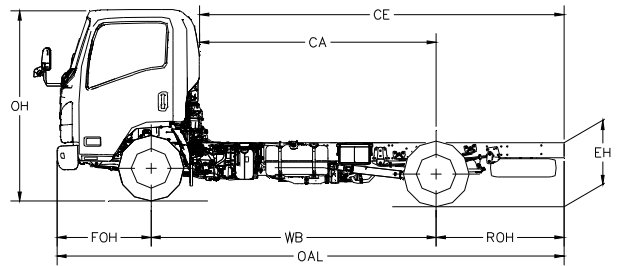
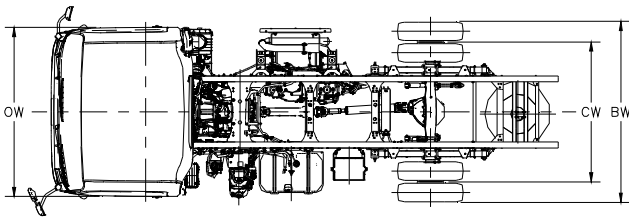

型號 (Model)	OAL	WB	FOH	ROH	CE	CA	OW	BW	CW	OH Approx	EH Approx	
NPR75HH-VI-C / NPR75HHE-VI-C	5985	3365	1110	1510	4302	2792	1995	2135	1650	2245	835	毫米 (mm)
	235.6	132.5	43.7	59.4	169.4	109.9	78.5	84.1	65.0	88.4	32.9	寸 (in)

NPR75KH-VI-C / NPR75KHE-VI-C

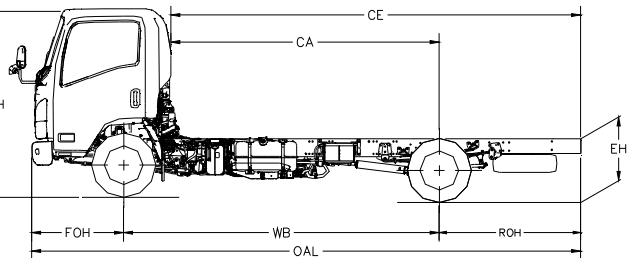
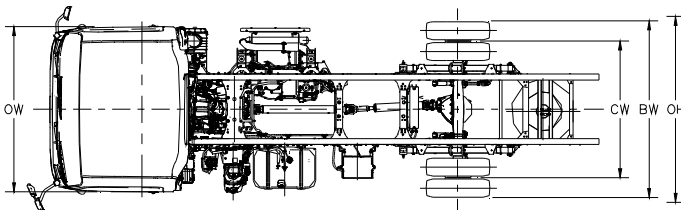

型號 (Model)	OAL	WB	FOH	ROH	CE	CA	OW	BW	CW	OH Approx	EH Approx	
NPR75KH-VI-C / NPR75KHE-VI-C	6635	3815	1110	1710	4952	3242	1995	2135	1650	2245	835	毫米 (mm)
	261.2	150.2	43.7	67.3	195.0	127.6	78.5	84.1	65.0	88.4	32.9	寸 (in)

以上尺寸只供參考。如有更改，恕不另行通告。

NPR75HJW-VI-C / NPR75HJWE-VI-C

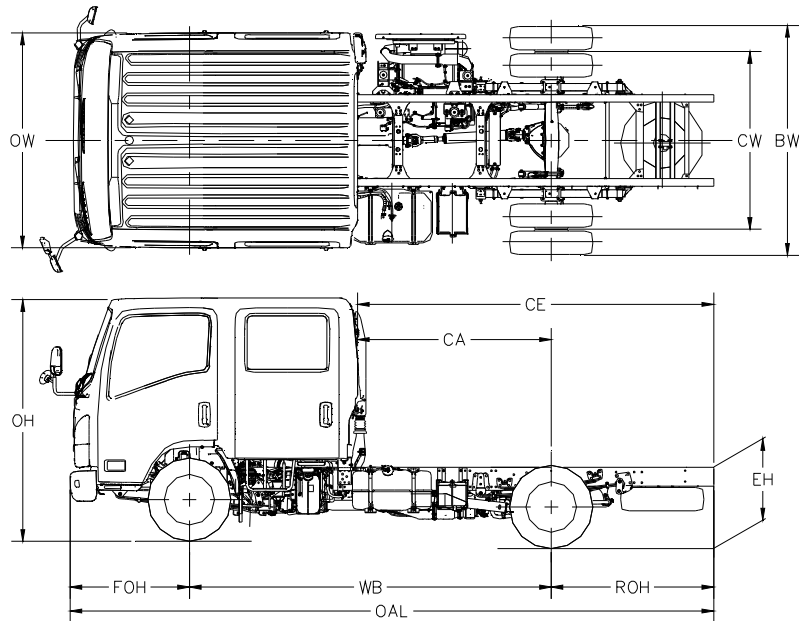

型號 (Model)	OAL	WB	FOH	ROH	CE	CA	OW	BW	CW	OH Approx	EH Approx	
NPR75HJW-VI-C / NPR75HJWE-VI-C	5985	3365	1110	1510	3311	1801	1995	2135	1650	2245	835	毫米 (mm)
	235.6	132.5	43.7	59.4	130.4	70.9	78.5	84.1	65.0	88.4	32.9	寸 (in)

NPR75KJW-VI-C / NPR75KJWE-VI-C

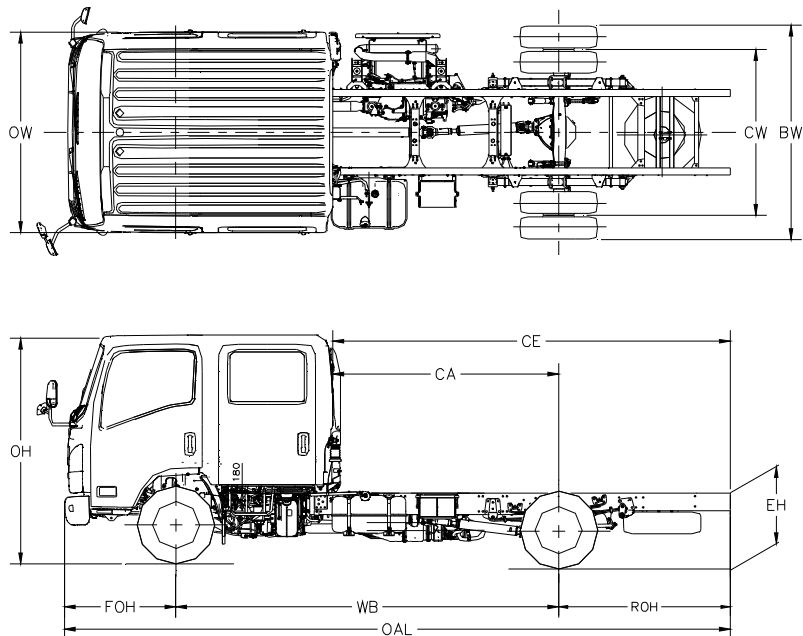

型號 (Model)	OAL	WB	FOH	ROH	CE	CA	OW	BW	CW	OH Approx	EH Approx	
NPR75KJW-VI-C / NPR75KJWE-VI-C	6635	3815	1110	1710	3961	2251	1995	2135	1650	2245	835	毫米 (mm)
	261.2	150.2	43.7	67.3	155.9	88.6	78.5	84.1	65.0	88.4	32.9	寸 (in)

以上尺寸只供參考。如有更改，恕不另行通告。

NPR75FL-VI-C / NPR75FLE-VI-C

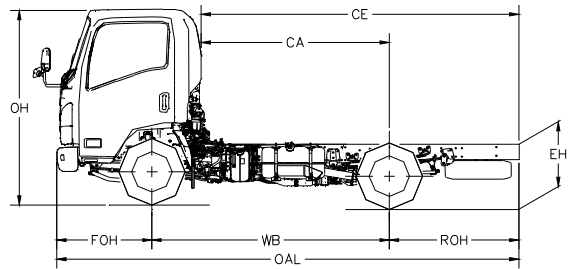
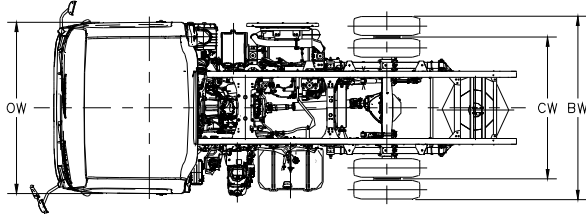

型號 (Model)	OAL	WB	FOH	ROH	CE	CA	OW	BW	CW	OH Approx	EH Approx	
NPR75FL-VI-C/ NPR75FLE-VI-C	5385	2765	1110	1510	3702	2192	1995	2115	1650	2280	835	毫米 (mm)
	212.0	108.9	43.7	59.4	145.7	86.3	78.5	83.3	65.0	89.8	32.9	寸 (in)

NPR75HL-VI-C / NPR75HLE-VI-C

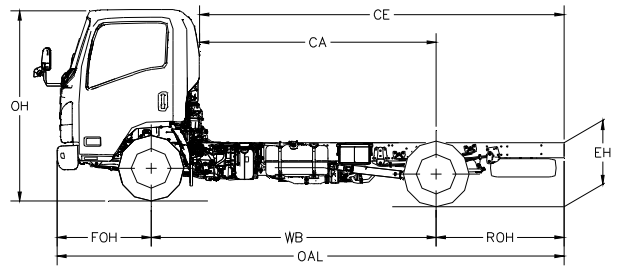
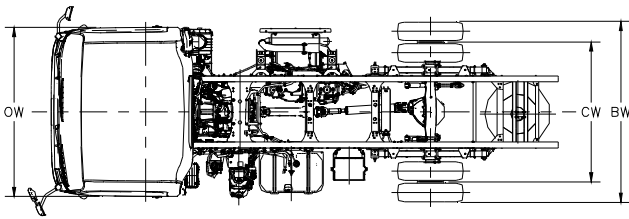

型號 (Model)	OAL	WB	FOH	ROH	CE	CA	OW	BW	CW	OH Approx	EH Approx	
NPR75HL-VI-C/ NPR75HLE-VI-C	5985	3365	1110	1510	4302	2792	1995	2115	1650	2280	835	毫米 (mm)
	235.6	132.5	43.7	59.4	169.4	109.9	78.5	83.3	65.0	89.8	32.9	寸 (in)

NPR75KL-VI-C / NPR75KLE-VI-C

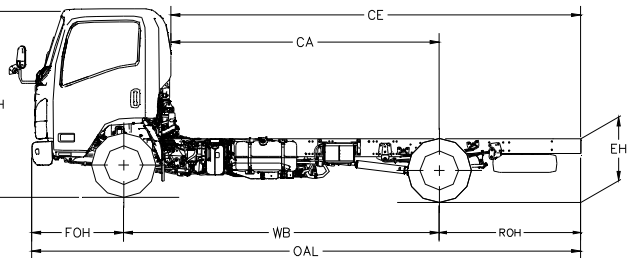
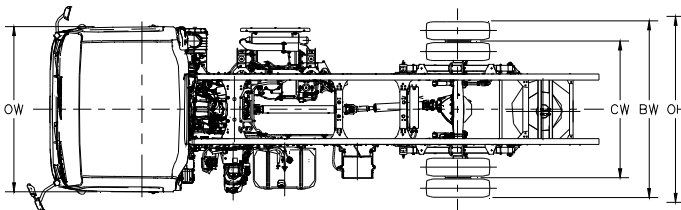

型號 (Model)	OAL	WB	FOH	ROH	CE	CA	OW	BW	CW	OH Approx	EH Approx	
NPR75KL-VI-C/ NPR75KLE-VI-C	6635	3815	1110	1710	4952	3242	1995	2115	1650	2280	835	毫米 (mm)
	261.2	150.2	43.7	67.3	195.0	127.6	78.5	83.3	65.0	89.8	32.9	寸 (in)

以上尺寸只供參考。如有更改，恕不另行通告。

